



iLoud[®] Micro Monitor

Studio reference monitor

USER MANUAL

Table of Contents

Contents	2
English	4
iLoud Micro Monitor	4
Register your iLoud Micro Monitor	4
iLoud Micro Monitor overview	5
Installation and setup	6
Control panel	10
Audio inputs	10
Speaker's connection ports	10
Bluetooth pairing	11
Volume	11
Power switch and DC input	11
Acoustic setup	12
Desktop filter	12
High frequency filter	13
Low frequency filter	13
LED	13
Drivers	13
Woofers	13
Tweeter	13
Bass port	14
Speakers placement	14
Desktop positioning	14
Listening position	15
Room acoustics	15
Microphone stand mounting	16
Block diagram	16
Troubleshooting	17
Specifications	17
Graphics	18
Warranty	19
Support and more info	19
中文	20
iLoud Micro Monitor	20
注册你的iLoud Micro Monitor	20
安装和设置	21
控制面板	25
音频输入	25
音箱连接端口	25
蓝牙配对	26
音量	26
电源开关的DC输入	26

声学设置	27
桌面滤波器	27
高频滤波器	28
低频滤波器	28
LED	28
驱动	28
低音单元	28
高音单元	28
低频倒相口	29
音箱放置	29
桌面定位	29
听音位置	30
房间声学设置	30
麦克风支架安装	31
故障排除	31
规格参数	32
保修政策	32
支持及更多信息	32

iLoud Micro Monitor

Thank you for purchasing iLoud Micro Monitor.

Your package contains

- iLoud Micro Monitor speakers
- Power supply unit
- Speakers connection cable
- RCA cable
- Quick start guide
- Registration card

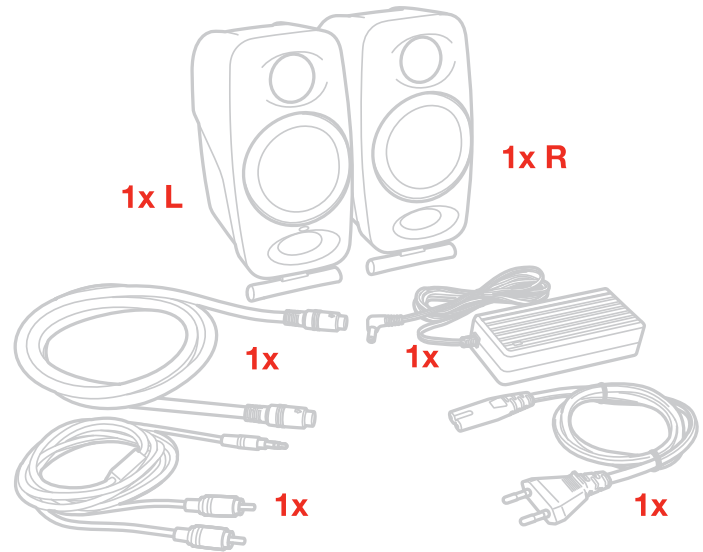

iLoud Micro Monitor is a full-featured ultra-compact stereo monitoring system.

It's a pair of portable studio monitors with a professional-quality bi-amplified design that provides an honest and accurate sound with a true linear frequency response.

iLoud Micro Monitor is powered by four amps that deliver a combined 50 W RMS of power. Each offer extreme clarity and superior bass response via two 3/4" tweeters and two 3" woofers.

These features are augmented by an on-board 56-bit DSP processor. It gives you total control of the monitor's performance, allowing for stunningly accurate and detailed sound that's hardly believable considering the size and price.

It can be adjusted to suit different playback situations thanks to its speakers' two positionable angles of inclination and three dedicated EQ switches: bass, treble and a "free field"/"desktop" compensation switch. These switches let you optimize its sound for your listening environment.

It also comes with a full range of source options that includes Bluetooth streaming as well as RCA and 1/8" inputs.

iLoud Micro Monitor is perfect for mixing, mastering, composing, producing, critically listening and more in a wide variety of situations both while traveling and while at home or in the studio.

Register your iLoud Micro Monitor

By registering, you can access technical support, activate your warranty and receive free JamPoints™ which will be added to your account. JamPoints™ allow you to obtain discounts on future IK purchases! Registering also keeps you informed of all the latest software updates and IK products.

Register at: www.ikmultimedia.com/registration

iLoud Micro Monitor overview



Active speaker (left)

Installation and setup

We recommend using high-quality audio cables to guarantee optimal performance. It is important to ensure the speakers stand firmly on a solid ground. Please note that the loudspeakers will need a few days to achieve optimum sonic performance.

1. Make sure that the volume control of iLoud Micro Monitor is set to minimum. Make sure that the ON/OFF switch on the rear panel is set to OFF.

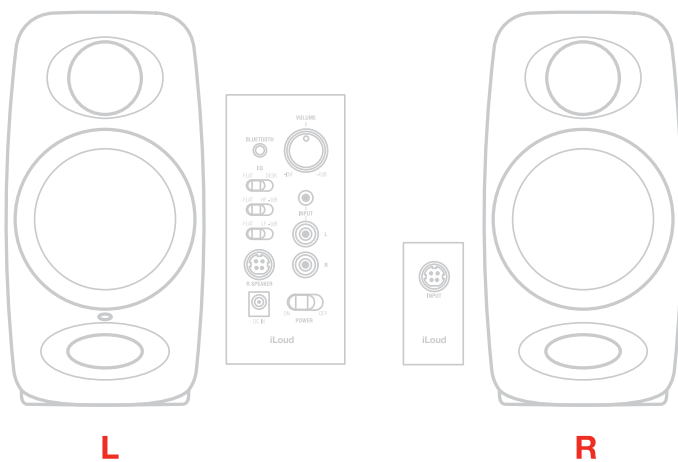

2. Connect the speakers with the included connection cable.

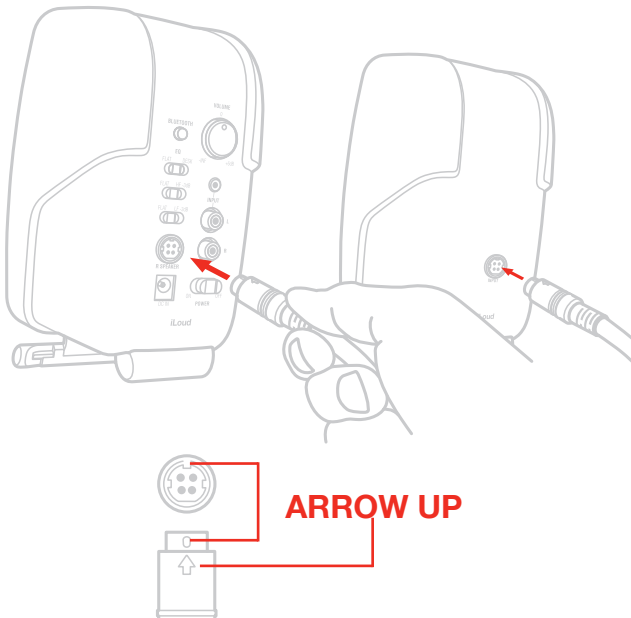

3. Connect the included PSU to the DC socket on the left speaker.

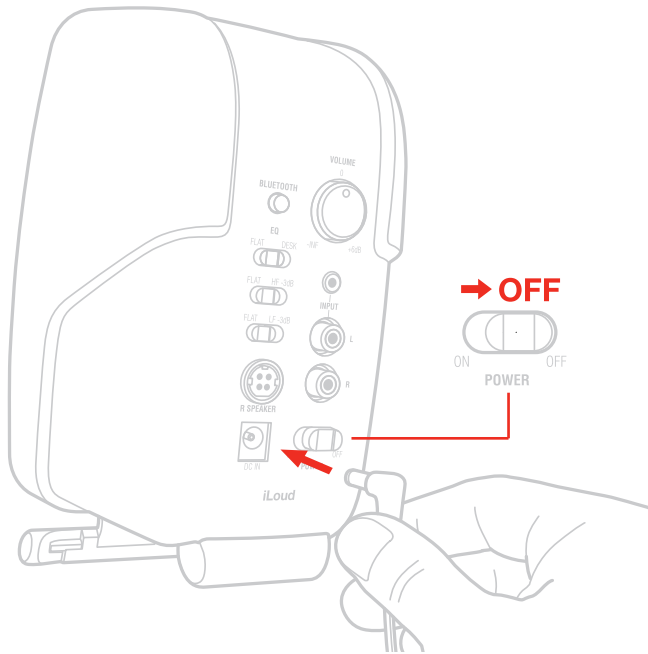

4. Connect your sound source to the left speaker. You can use both the 1/8" jack input or the unbalanced RCA stereo inputs.

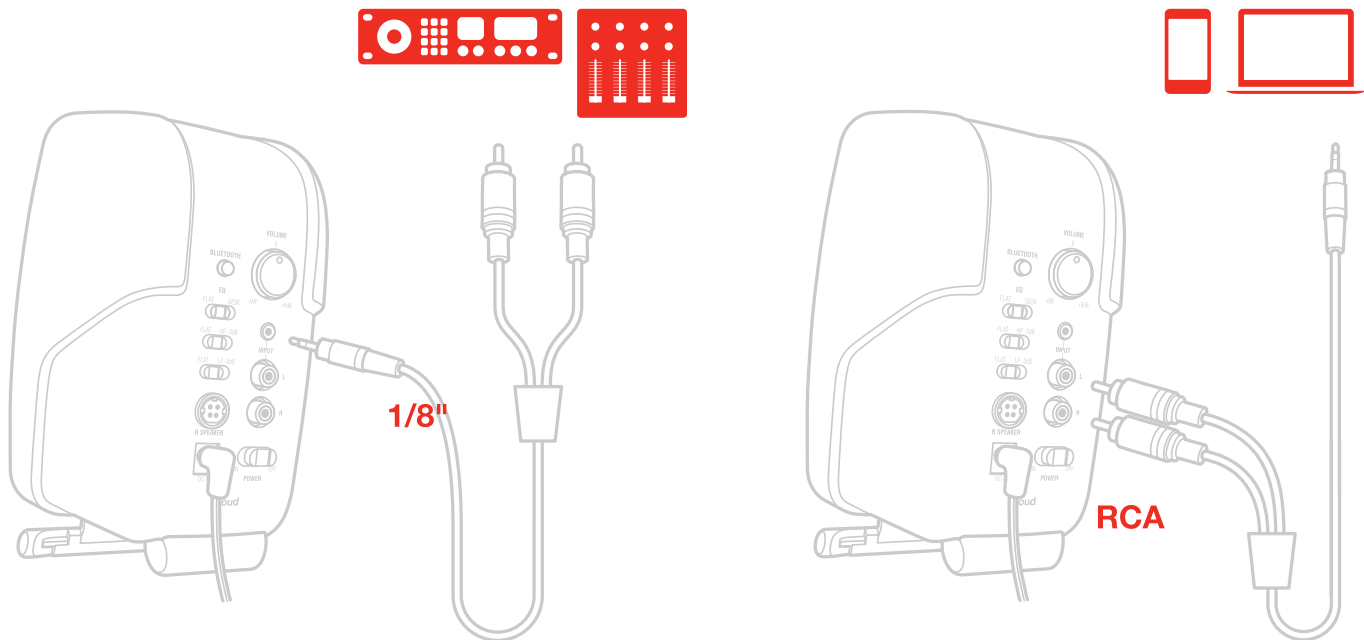

5. Switch ON the main ON/OFF switch on the rear panel of the left speaker.

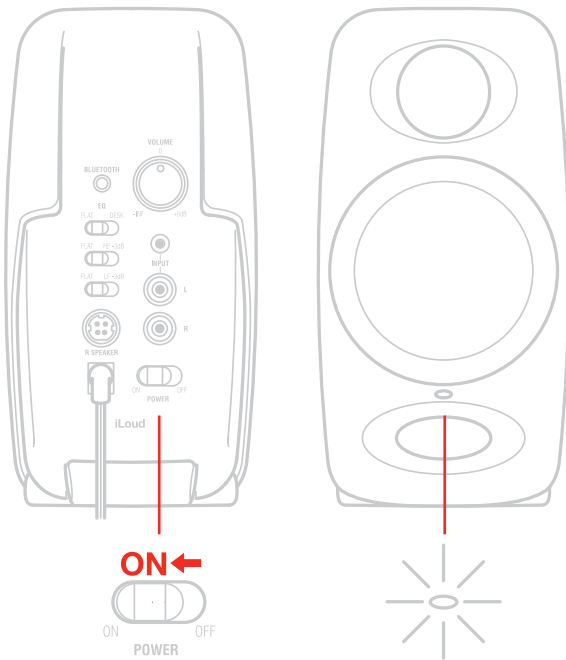

6. It is also possible to stream audio wirelessly by pairing a Bluetooth® device with iLoud Micro Monitor.

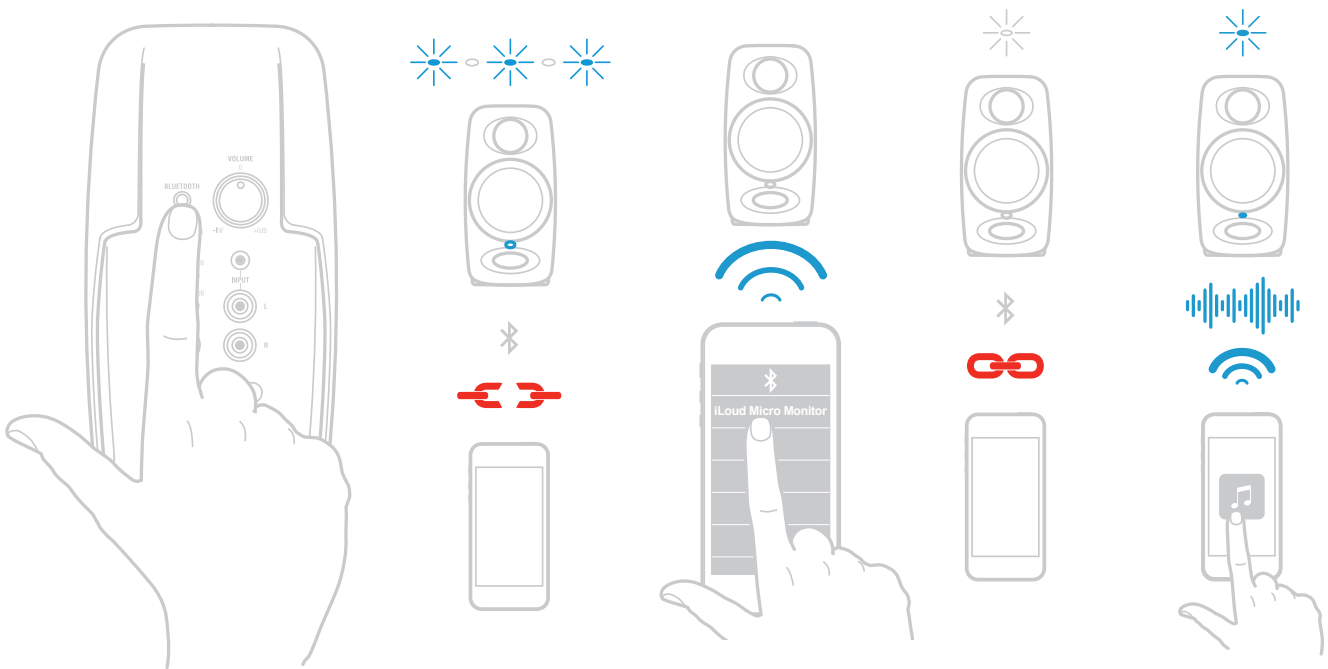

7. Play audio from your audio source and slowly raise the volume of the iLoud Micro Monitor to a comfortable listening level.

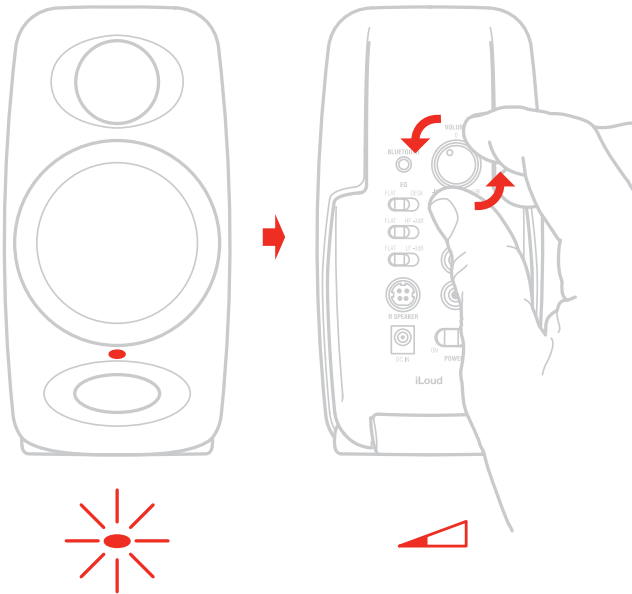

8. If needed, adjust the speakers response with the dedicated controls on the rear panel of the left speaker.
9. If needed adjust the speakers inclination with the tilting pads.

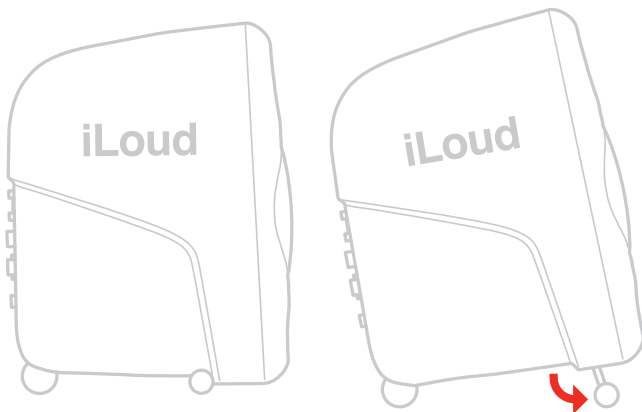

Note: Before plugging in and turning on, remember the “last on, first off” rule of powered speakers. When powering up your system, be sure that all the wires are connected, turn your mixer/interface and any other outboard gear on, and then last turn on your iLoud Micro Monitor. When powering down, turn your iLoud Micro Monitor off first and then your mixer/interface and outboard gear.

Control panel

Audio inputs

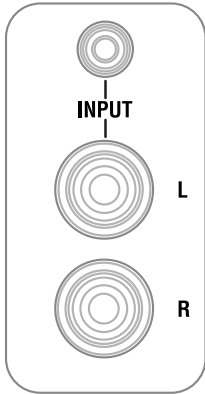

RCA unbalanced line input

These RCA jacks allow for the connection of line sources (i.e., mixer/audio interface bal/unbal line out) both for the Left and Right channel.

1/8" AUX unbalanced input

This unbalanced line input allows for the connection of stereo unbalanced audio sources (i.e., computer stereo output, music player stereo output, smartphone/tablet stereo output).

Speaker's connection ports



These ports (present on both speakers) allow you to connect the active speaker (Left port) with the passive speaker (Right one). These are 4 pins connectors: in this way it is possible to carry the powered signal both for the HF driver and the LF driver.

Bluetooth pairing



The iLoud Micro Monitor uses Bluetooth® to stream high quality audio from your Bluetooth® enabled device without the need to connect any audio cable. In order for your device to work with the iLoud Micro Monitor it must first be paired. To pairing your device:

- Turn the back panel volume control counter-clockwise to the -INF position.
- With the iLoud Micro Monitor and your Bluetooth® device powered on: press the PAIRING button on the rear panel of the Left speaker to make the speaker discoverable. The front panel indicator will slowly flash blue.
- In the settings of your Bluetooth® device, set it to “discover” available devices.
- From the Bluetooth® device list, select the “iLoud Micro Monitor” device.
- iLoud Micro Monitor indicates that pairing is complete when the indicator returns steady white. You can now stream audio from your device to the iLoud Micro Monitor: only when there’s an audio streaming the LED turns steady blue.
- With the volume control on your Bluetooth® device turned up, play some music and slowly raise the iLoud Micro Monitor volume control until you have reached the desired level.

Volume

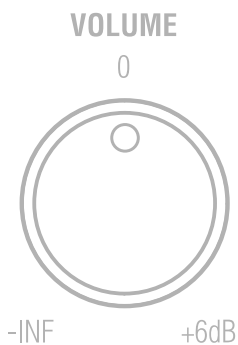

This potentiometer allows you to adjust the input level of the audio source.

Power switch and DC input

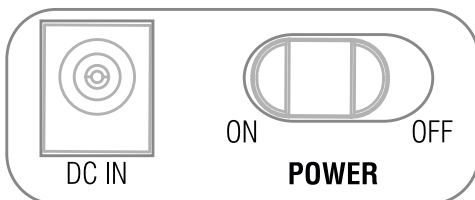

Power switch: this rocker-style switch allows to power on and off iLoud Micro Monitor.

DC IN: connect the (included) PSU to this DC socket.

IMPORTANT: before to connect/disconnect the DC input, make sure that the power switch is set to Off.

Acoustic setup

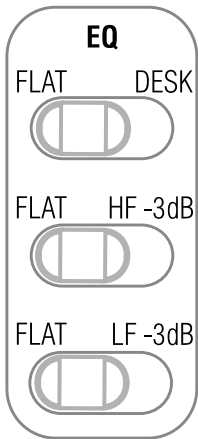

These three switches on the back panel will help you to fit perfectly iLoud Micro Monitor in every acoustic environment.

Desktop filter



This switch sets a notch filter to compensate the typical acoustic effect of a console or a desktop. Such placement usually results in a peak in the lower midrange. The Desktop switch activates a bell shaped notch filter, with a +3.5dB between 1kHz and 10kHz and -1dB below 400Hz.

High frequency filter

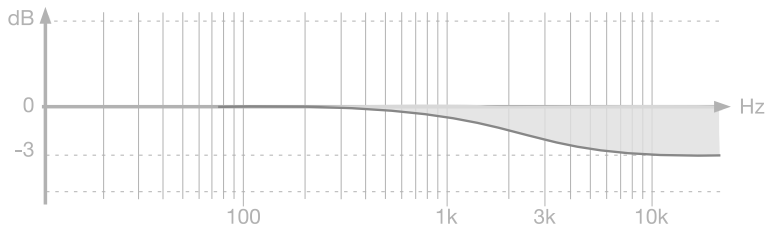

This switch controls the high frequency level using a shelf-type EQ. The level can be set to 0dB or -3dB (above 4kHz). This filter is used to match the high-end of the monitor with your acoustical environment. If the sound is too bright try to slide the switch to the right to reduce trebles by 3dB.

Low frequency filter

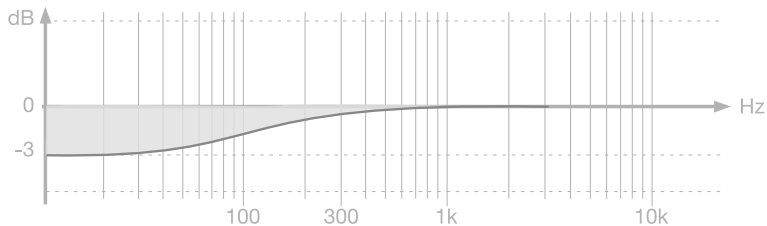

This switch controls the low frequency level using a shelf-type EQ. The level can be set to 0dB or -3dB (below 250Hz).

This filter is used to adjust the proximity effect of side walls and ceiling. Use this filter whenever the acoustics of your room cause problems in the low frequency range.

LED

The frontal LED on the Left speaker will show important information about iLoud Micro Monitor's status:

Steady white: iLoud Micro Monitor is ON.

Steady red: clipping.

Flashing blue: iLoud Micro Monitor is pairing with your Bluetooth device.

Steady blue: the Bluetooth connected device is streaming audio to the speakers.

Drivers

Woofers

The woofer unit is a custom 3" paper cone capable to delivers balanced mid- and low-frequency response.

Tweeter

By employing a specially developed 3/4" silk cone with neodymium magnet, the tweeter can deliver an extremely natural response on the top-end.

Bass port

The hole in the front panel is a bass reflex port. It is designed to discharge the low frequency signals and enhance the overall bass response.

Speakers placement

Please make sure that no obstacles are presents in the way from the monitors to your ears. You should be able to see the speakers completely. iLoud Micro Monitor has been designed for a vertical set up. The speakers must be positioned on a firm ground or a stand.

Please note that vibrating parts of nearby objects can mask the sound.

Desktop positioning

The point between the woofer and the tweeter should be positioned approximately at the height of your ears. In case you need to position the speakers in a significant lower or higher position, the monitors should be angled accordingly. If the speakers are placed lower than the ear line, you can tilt them with the integrated rubber pads that, also, improves the acoustic decoupling of the speakers from the surface.



Listening position

When you use iLoud Micro Monitor for stereo applications, the optimum listening position should be located in the middle of an imaginary triangle. This means that your listening point (sweet point) will be located at the top of an equilateral triangle and the two loudspeakers should be placed at the other two points of this triangle. Furthermore, a symmetrical positioning is also important: this applies to the distance between speakers as well as to the walls, ceiling and floor. In order to have a symmetrical stereo image it is also important to have symmetrical reflections: we recommend to keep a distance of at least 20 cm (8 inches) from the walls, in order to avoid low frequency boosting.

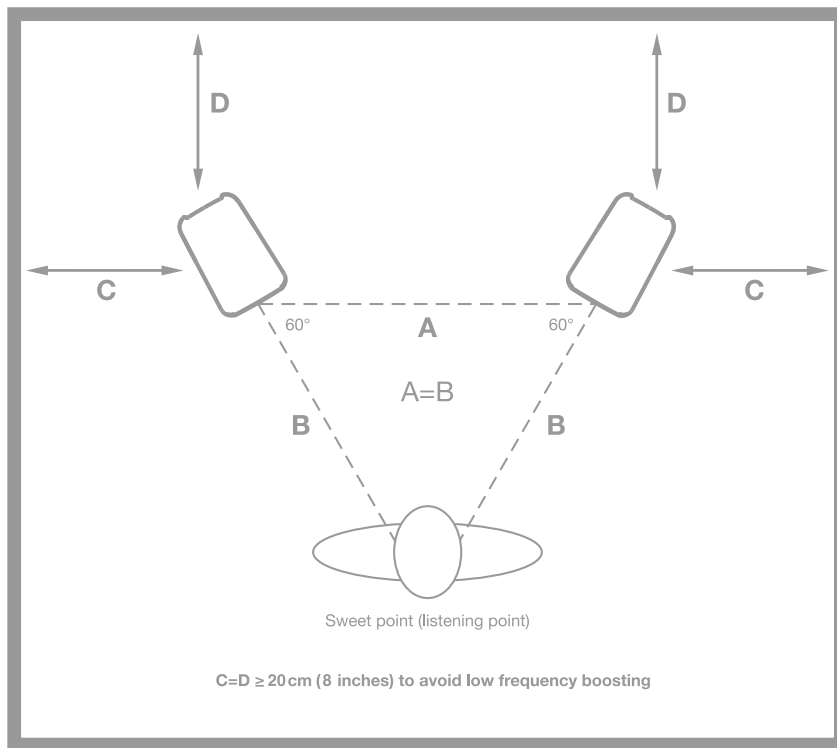

Room acoustics

The room acoustics plays a key role in the performance of your monitoring system. It is always advisable to make, at least, a minimum of acoustic treatment of your environment. This, along with the correct monitor's positioning, will improve the linearity and the precision of the listening.

Microphone stand mounting

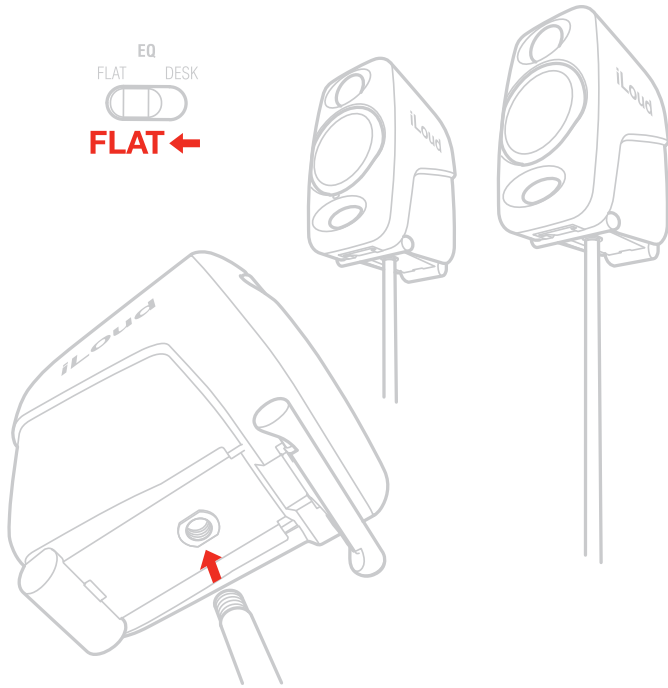

Thanks to the thread adapter on the bottom of the speakers, iLoud Micro Monitor can be mounted on any standard 3/8" microphone stand. This allows you to place the speakers at the perfect height and, most important, helps to reduce the typical reflections of the desktop (or shell) and, consequently, improves the frequency response/linearity of the speaker.

Block diagram

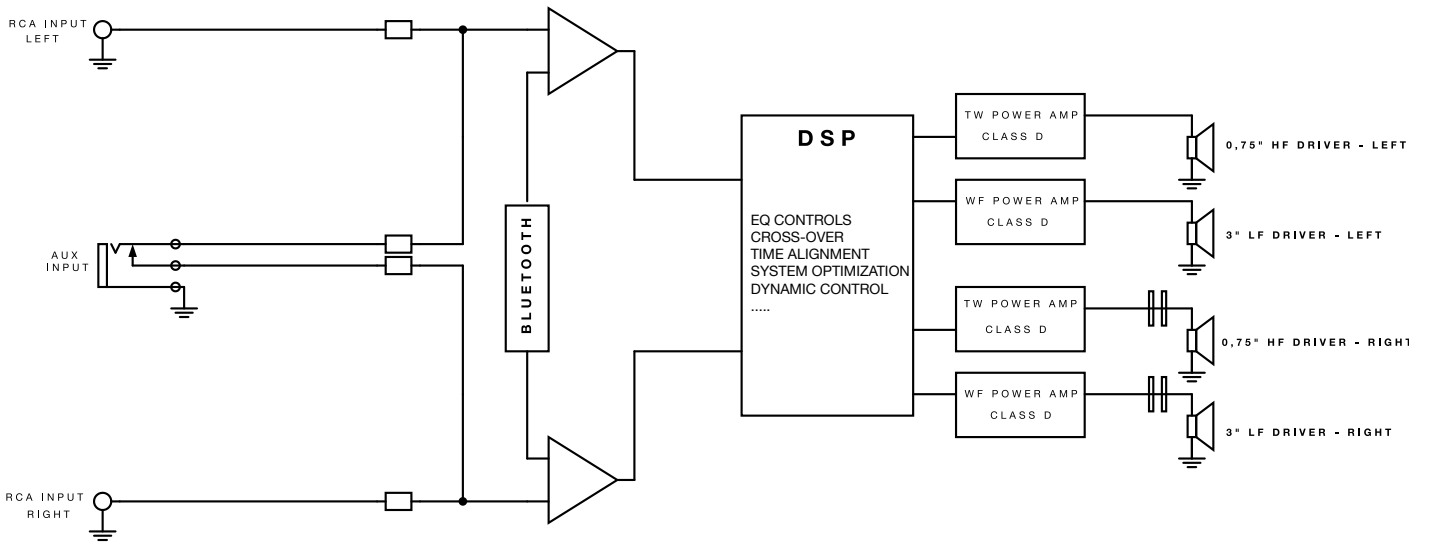

Troubleshooting

I have connected my device to iLoud Micro Monitor, but no sound comes out.

Make sure to set up the volume with the volume potentiometer on iLoud Micro Monitor and/or with your device's volume control.

Sound is distorted.

When a noticeable distortion occurs, please turn down the level of the speakers, or of the connected audio source.

Specifications

- **Type:** 2-way active, bi-amped, studio monitor
- **Frequency response (-3dB):** 55Hz - 20kHz
- **Frequency response (-10dB):** 45 Hz - 22 kHz
- **Crossover Frequency:** 3kHz
- **Tweeter:** 3/4" silk dome and neodymium magnet
- **Woofers:** 3" paper cone
- **Maximum SPL @ 50cm (with two speakers playing, averaged sine wave from 100 Hz to 10 kHz):** 107dB
- **Number of amplifiers:** 4
- **Amplifiers type:** Class-D
- **Total output power (both speakers):** 70W (peak) - 50W RMS
- **Woofers output power (single speaker):** 18W RMS
- **Tweeter output power (single speaker):** 7W RMS
- **Acoustic settings:** high shelf (0dB or -3dB from 4kHz up); low shelf (0dB or -3dB from 250Hz down); desktop (+3.5dB between 1kHz and 10kHz and -1dB below 400Hz)
- High performance Bass-Reflex port
- Bluetooth® compatible with A2DP protocol
- 56-bit DSP internal resolution
- **System total latency (analog input):** 1.02 ms
- **System total latency (Bluetooth input):** 155 ms (depends on host implementation, tested on iPhone 6S / iOS 10.0.1)
- **Connectors:** 2x RCA unbalanced input; 1/8" AUX stereo input (unbalanced); 4-pin speakers connector
- **Dimensions (inches):** 180mm x 135mm x 90mm (7" x 5.31" x 3.54")
- **Weight (oz):** 920g (32.45oz) left speaker - 800g (28.22oz) right speaker

Graphics

ILOUD MICRO MONITOR FREQUENCY RESPONSE
(normalized at 0dB)

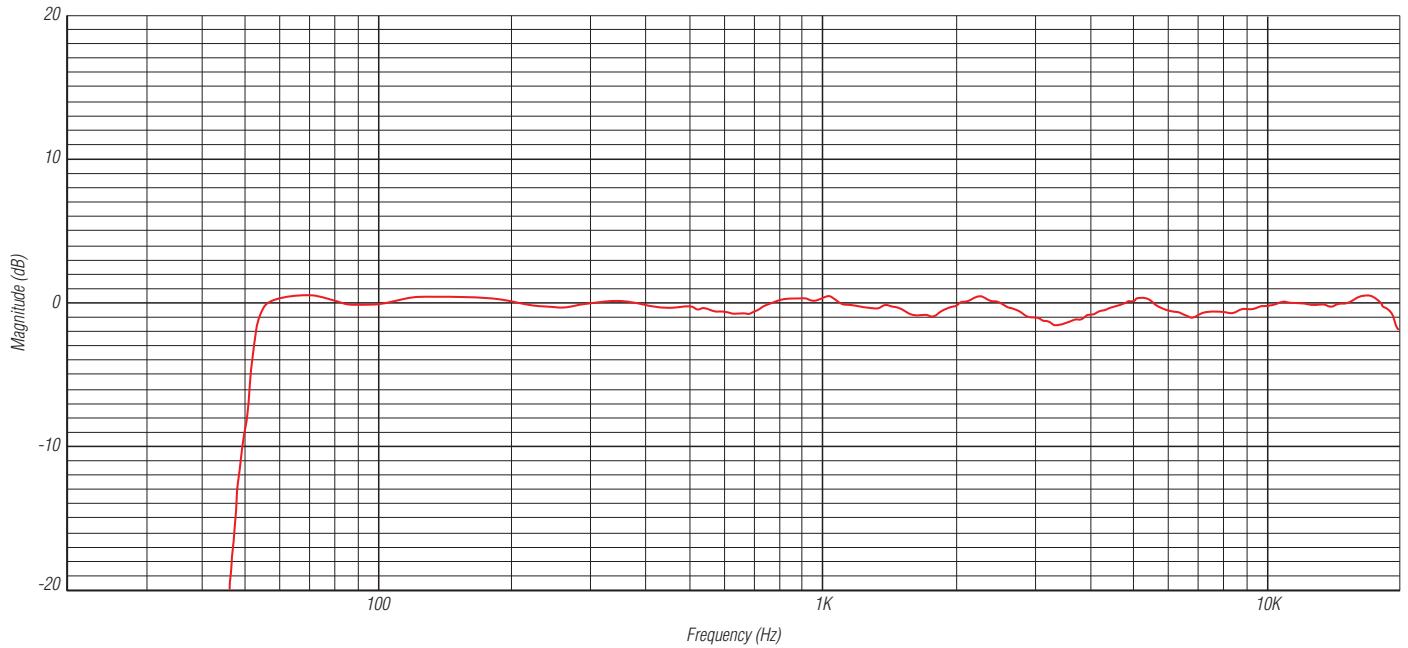

Measured at 1 meter distance, in anechoic chamber, on tweeter axis.
All calibration switches set to "FLAT"

ILOUD MICRO MONITOR MAXIMUM SPL

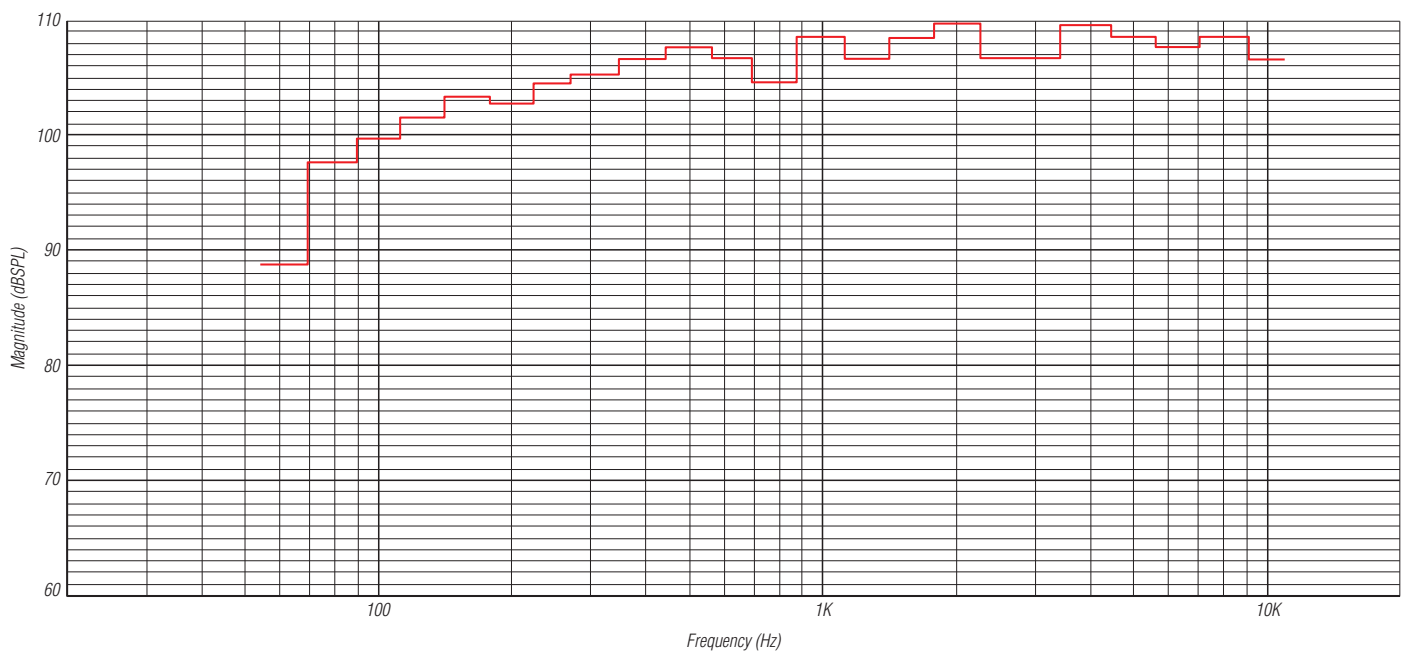

Measured at 50 cm distance, with two speakers playing, for 10% THD.

Warranty

Please visit:

www.ikmultimedia.com/warranty

for the complete warranty policy.

Support and more info

www.ikmultimedia.com/support

www.iloudmm.com

iLoud Micro Monitor

感谢您购买iLoud Micro Monitor。

盒子内包含

- iLoud Micro Monitor音箱
- 电源适配器
- 音箱连接线
- RCA线材
- 快速启动指南
- 注册卡

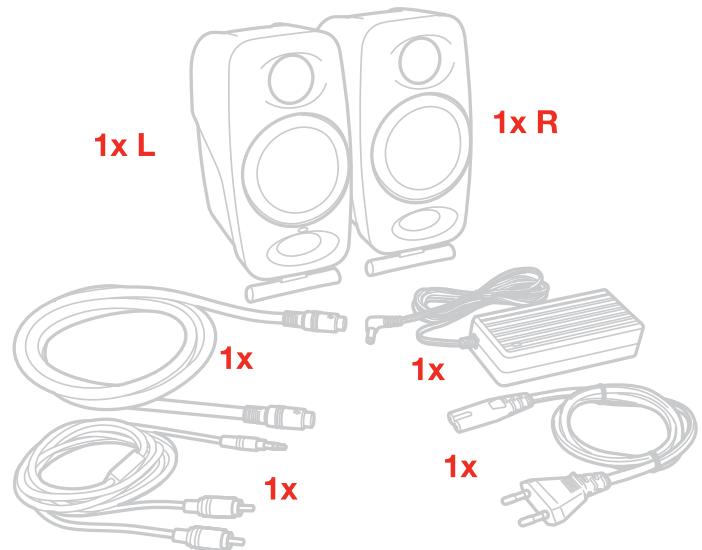

iLoud Micro Monitor是一个全功能超小型立体声监听系统。

这是一对便携式录音棚监听音箱，带有专业品质的双功放设计，其真实的线性频率响应提供诚实而精确的声音。

iLoud Micro Monitor由四个放大器输送一个组合50 W RMS的功率驱动。通过两个3/4”高音单元和两个3”低音单元，每个音箱都提供清晰、卓越的低音响应。

这些功能因板载的56位DSP处理器而得以增强。它让你完全控制音箱的性能，带来非常精确和详细的聲音，这在考量的尺寸和价格内是难以实现的。

它能够调整以配合不同的播放情况，这得益于其扬声器的两个可定位的倾向角度和三个专用的EQ开关：低频、高频和“自由场”/“桌面”补偿开关。这些开关让你优化它的声音，配合你的听音环境。

它还配备了一个全方位的音源选项，包括蓝牙流以及RCA和1/8”输入。

iLoud Micro Monitor可完美用于混音、母带处理、作曲、创作、苛刻的听音环境，以及各种情况下的使用，无论是旅行途中，在家或在录音棚。

注册你的iLoud Micro Monitor

通过注册，您可以访问技术支持，激活您的保修并收到免费的JamPoints™添加到您的账户。JamPoints™让您在以后购买IK产品时享受优惠！注册也让您能够了解到所有最新软件更新和IK产品的信息。

注册网址：www.ikmultimedia.com/registration

安装和设置

我们建议使用高品质音频线以保证最佳的性能。一定要确保音箱稳定的放置在坚实的平面上。请注意，音箱需要几天才能达到最佳的声音性能。

1. 确保iLoud Micro Monitor的音量控制设置为最低。确保后面板上的ON/OFF开关是OFF状态。

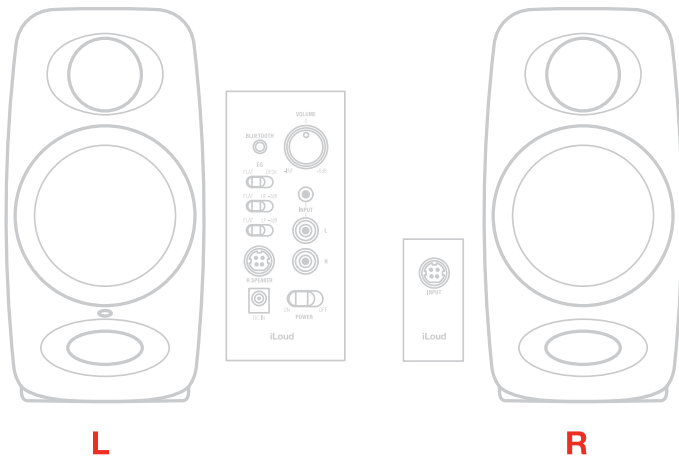

2. 使用配备的连接线材连接音箱。

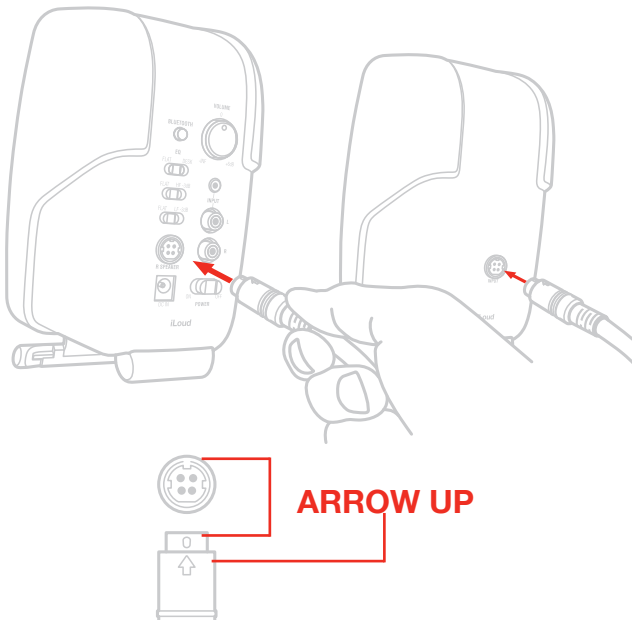

3. 连接配备的电源适配器到左音箱的DC接口

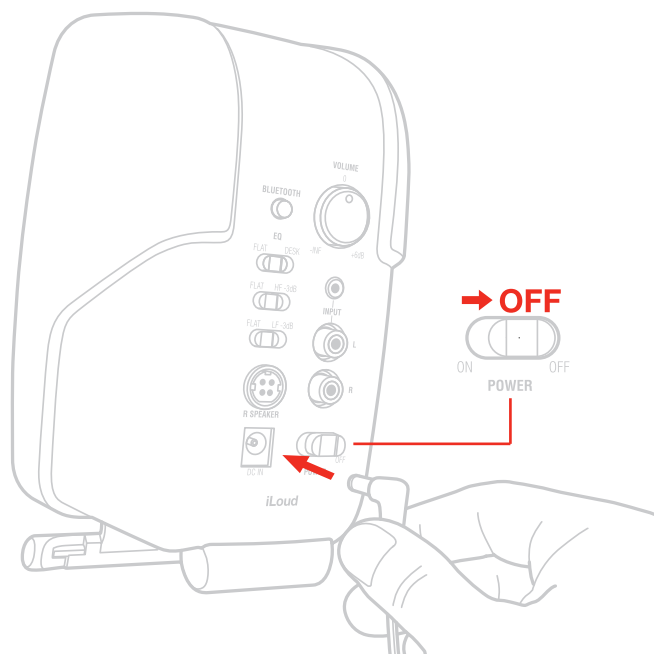

4. 将音源连接到左音箱。可以使用3.5mm接口输入或非平衡RCA立体声输入。

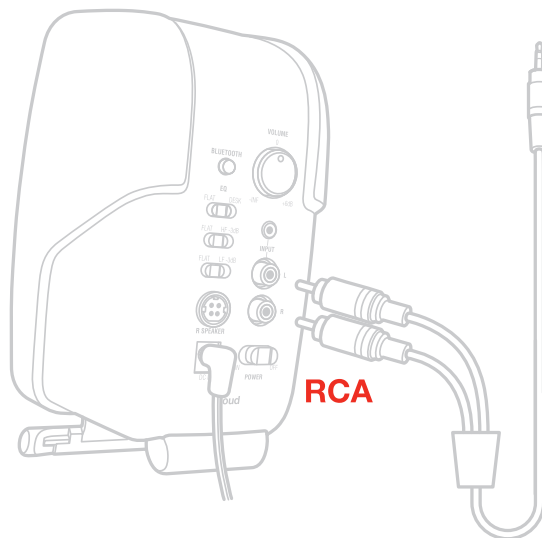
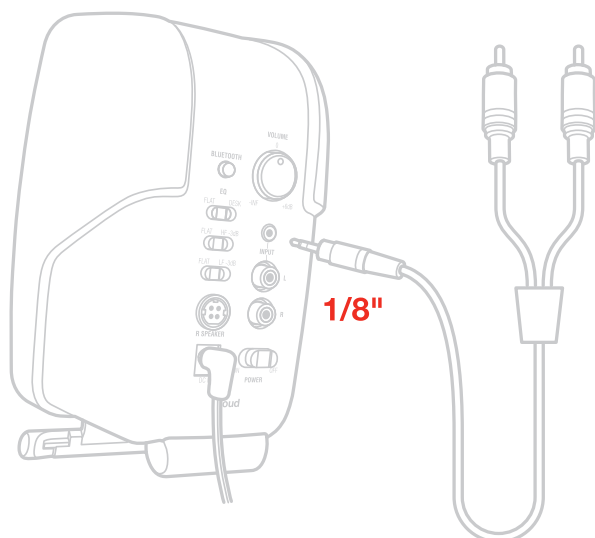

5. 打开左音箱上背面的ON/OFF开关

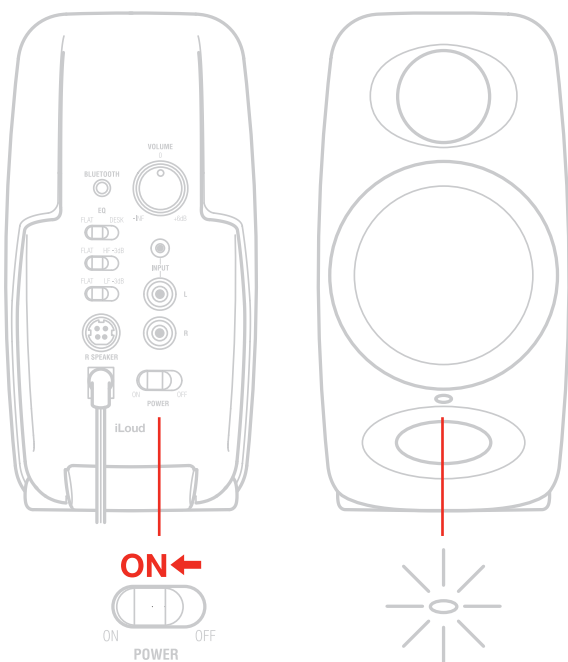

6. 同样可以通过蓝牙无线连接到iLoud Micro Monitor播放音频

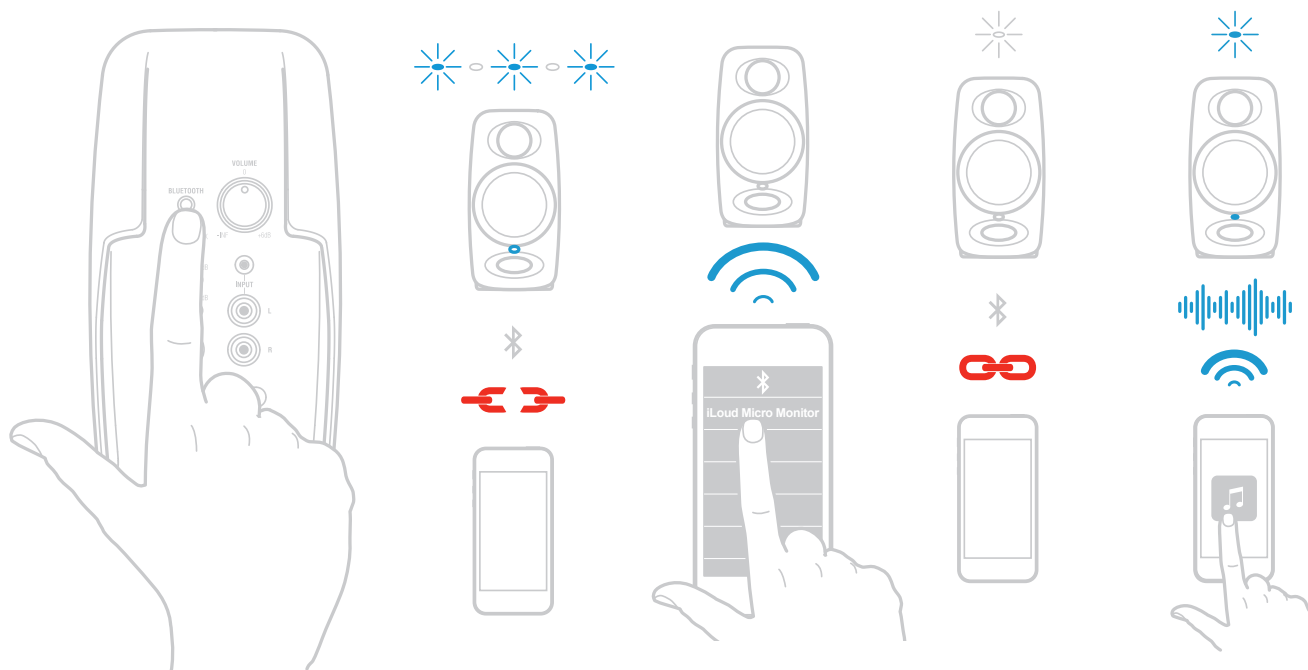

7. 从您的音源播放音频并缓慢转动iLoud Micro Monitor 的音量旋钮调整到舒适的音量大小。

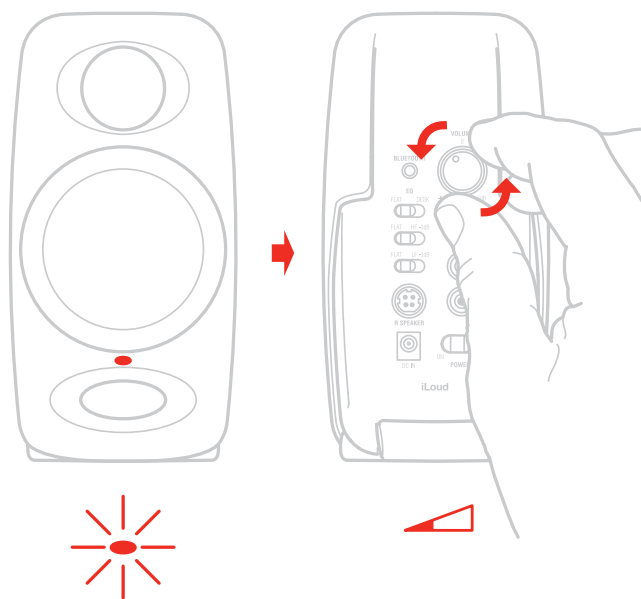

8. 如果需要，可以通过左音箱背面的专用控制调节音箱的响应。

9. 如果需要调整音箱的角度，可以使用底部的支架。

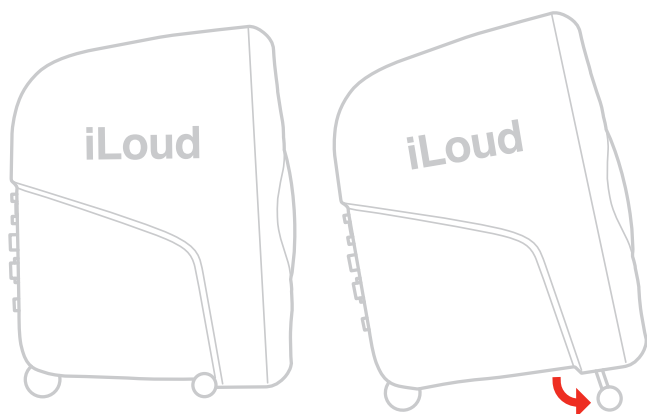

注意：在连接音源和开启前，记住“后开机，先关机”的原则来给音箱供电。当启动系统时，先确保所有线材都已经连接了，打开你的混音台/接口和其他设备，然后最后打开你的iLoud Micro Monitor。当关闭系统时，先关闭iLoud Micro Monitor的电源然后再关闭你的混音台/接口和其他装备。

控制面板

音频输入

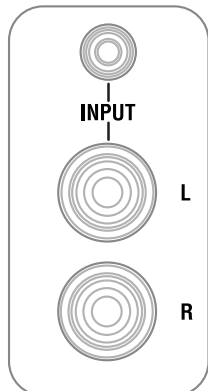

RCA 非平衡线性输入

这组RCA接口让你可以连接任何线性音源（例如：混音台/音频接口平衡/非平衡线性输出）到左右声道。

3.5mm AUX 非平衡输入

这个非平衡线性输入让你可以连接立体声非平衡音源（例如：电脑立体声输出，播放器立体声输出，手机/平板电脑立体声输出）

音箱连接端口



这个接口（在每个音箱后面）让你可以连接主音箱（左音箱）和副音箱（右音箱）。它是一个4-pin 接口：这样可以在给音箱供电的情况下同时传输高频驱动和低频驱动。

蓝牙配对

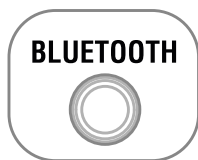

iLoud Micro Monitor 使用蓝牙来从设备无线传输高品质音频信号，在使用iLoud Micro Monitor 播放之前需要先进行配对，来匹配连接您的设备：

- 将背部面板的音量控制旋钮调节到 $-INF$ 的位置
- 打开您的iLoud Micro Monitor电源并开启需要连接蓝牙的设备：点击左音箱背部的PAIRING 按钮来将设备变为可发现状态，设备前面板的指示灯将缓慢闪烁蓝灯。
- 在您的蓝牙设备设置中，允许其“扫描”可用设备。
- 在蓝牙可用设备列表中，选择“iLoud Micro Monitor”设备。
- 当iLoud Micro Monitor 的指示灯回到白色的固定状态表示配对已经完成，现在你可以使用iLoud Micro Monitor来播放音源：当有音源输入后LED指示灯变为蓝色。
- 当您的蓝牙音量开启后，播放一些音乐并缓慢的加大iLoud Micro Monitor的音量直到它达到您想要的效果。

音量

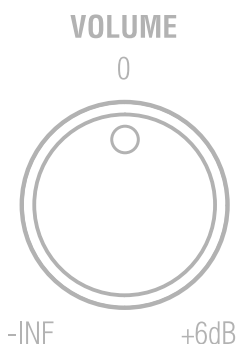

这个指示开关让你可以调整输入音源的音量

电源开关的DC输入

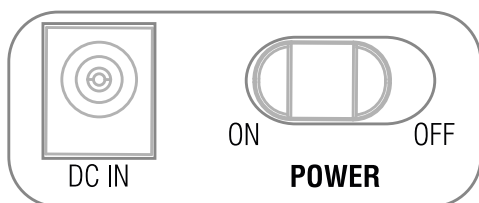

电源开关：这个拨动式开关让你可以开启和关闭iLoud Micro Monitor电源。

DC IN：连接电源适配器（附带）到设备

重要：当您连接/断开电源适配器的时候，确保电源开关保持在OFF（关闭）状态。

声学设置

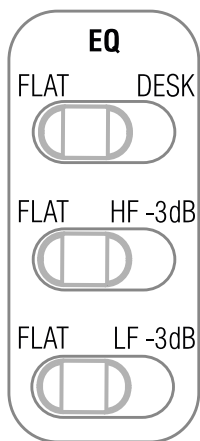

这三个位于背部面板的开关可以帮助您将iLoud Micro Monitor在不同的声学环境中调整到最佳状态。

桌面滤波器



此开关设置陷波滤波器以补偿控制台或桌面的典型声学效果，在较低的中频中改变了峰值的结果，Desktop 开关激活了钟形陷波滤波器，在1kHz到10kHz以及-1 dB低于400Hz的区间+3.5dB。

高频滤波器

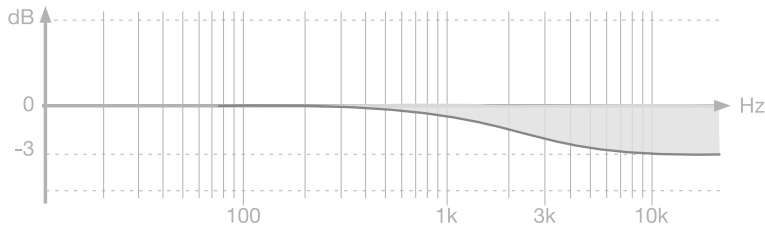

这个开关通过使用搁架式EQ来控制高频等级，等级可以设置为0dB或-3dB（高于4kHz）。这个滤波器让您在声学环境中可以调整监听音箱的高频，如果您觉得音色太过明亮可以尝试将开关调节到右边来给高音部降低3dB。

低频滤波器

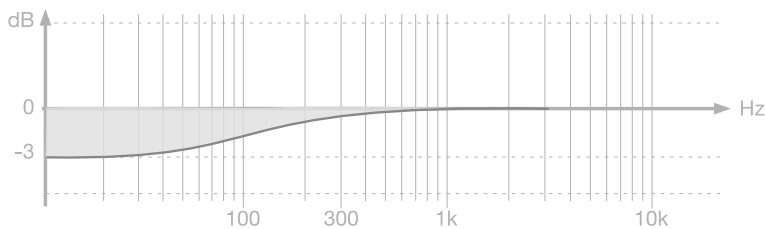

这个开关通过使用搁架式EQ来控制低频等级，等级可以设置为0dB或-3dB（250Hz以下）。该滤波器用于调整侧壁和天花板的邻近效应。当您的房间因为声学问题对音频造成影响时可以使用这个滤波器。

LED

位于左音箱正面的LED用于显示iLoud Micro Monitor的重要状态信息：持续白色：iLoud Micro Monitor 电源已开启

持续红色：限幅

蓝色闪烁：iLoud Micro Monitor 正在和蓝牙设备配对

持续蓝色：以连接的蓝牙设备正在输入音频信号到音箱

驱动

低音单元

低音单元采用了一个定制3”纸锥来提供平衡的中频和低频响应。

高音单元

通过使用特别开发的3/4”丝球搭配钕磁铁，高音单元在高频范围内可以带来及其自然的响应。

低频倒相口

位于前面板的这个洞口为倒相口，它的设计是用来释放低频信号并加强整体的低频响应。

音箱放置

请确保没有任何障碍物放置在音箱和您的耳朵之间，您应当确保可以完整的看到音箱。iLoud Micro Monitor 的设计采用了垂直的模式，音箱必须放置在坚固的平面或支架上。

请注意音箱附近的物品震动将会影响音色。

桌面定位

位于高音单元和低音单元的中点应当摆放在和耳朵大约一致的高度，如果您需要将音箱放置在特别矮或特别高的位置，音箱的角度需要相应的调整。如果音箱的放置位置低于耳朵，您可以使用音箱底部的支架调整，同时也改善了扬声器和桌面的声学耦合。



听音位置

当您使用iLoud Micro Monitor 搭配立体声软件使用，最佳的听音位置应该位于等边三角形上。这意味着您的听音点 (sweet point) 将落在等边三角形的顶点上，2个音箱应该分别位于等边三角形的另外两个顶点。此外，一个对称的位置同样重要：应用于两个音箱的间距以及和墙面、天花板、地板的间距。为了得到一个对称的立体声图像，对称的反射同样重要：我们建议和墙面至少保持20 cm (8英寸) 的距离，来避免低频堆积。

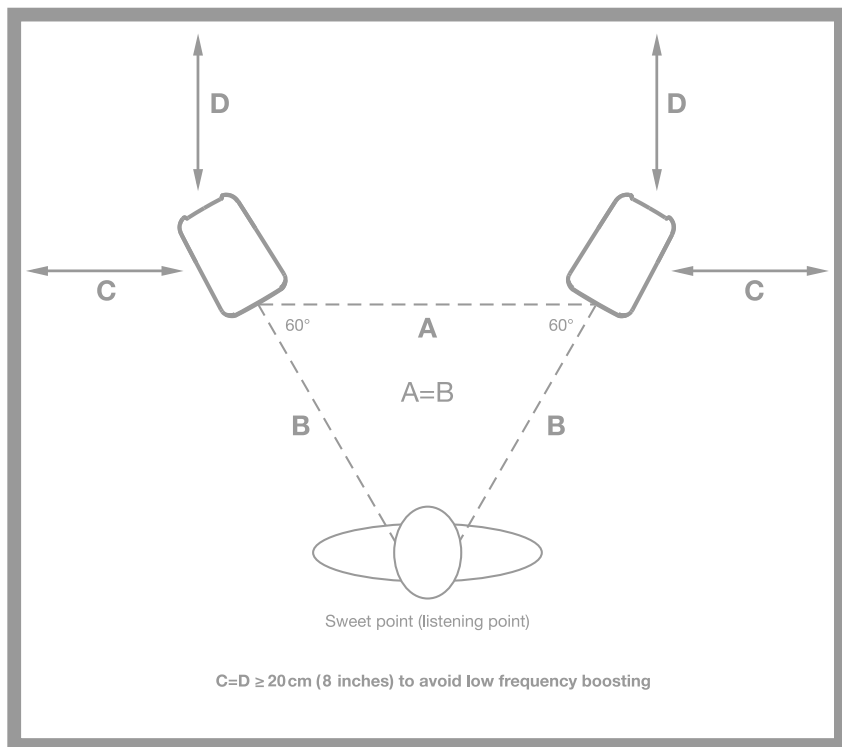

房间声学设置

房间的声学在监听系统的表现中起到关键的作用，建议您至少对您的环境做最基本的声学处理。搭配正确的监听音箱位置摆放，可以提高听音的线性和精确度。

麦克风支架安装

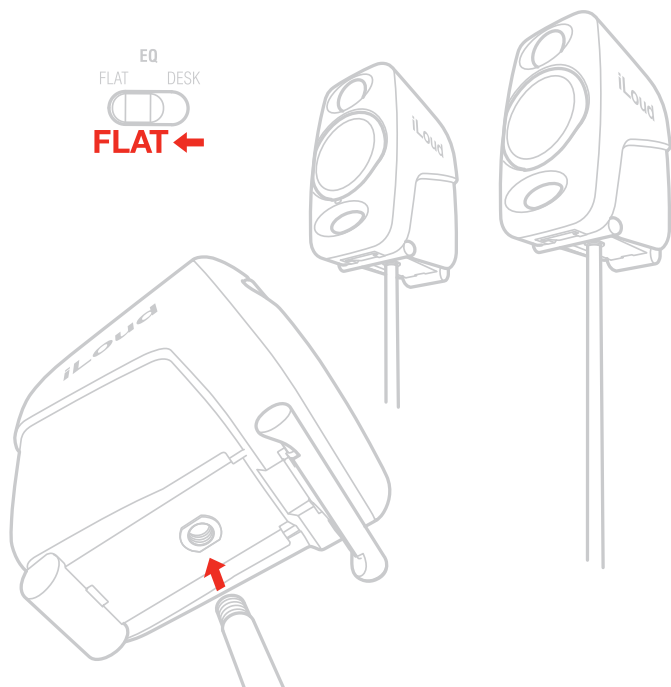

因为有了音箱底部的麦克风支架接口，iLoud Micro Monitor 可以连接到任何标准3/8” 麦克风支架上。这让你可以将音箱摆放在完美的高度，更重要的是，减少了桌面（或外壳）的反射，提升音箱的频率响应/线性。

故障排除

我已经连接了我的设备到iLoud Micro Monitor，但是没有声音。

确保您调整过iLoud Micro Monitor的音量控制按钮或调整设备的音量控制。

声音失真

当可辨认的失真发生时，请调低音箱的音量或调低音源的音量。

规格参数

类型：2路供电，双功放，录音棚监听音箱

频率响应 (-3dB)：55Hz - 20kHz

频率响应 (-10dB)：45 Hz - 22 kHz

交叉频率：3kHz

高音单元：3/4" 丝膜球顶和钹磁体

低音单元：3" 纸锥

最大SPL @ 50cm (使用双音箱播放，从100Hz到10kHz平均正弦波)：107dB

功放数量：4

功放类型：D类

总输出功率 (双音箱)：70W (峰值) - 50W RMS

低音单元输出功率 (单音箱)：18W RMS

高音单元输出功率 (单音箱)：7W RMS

声学设置：high shelf (0dB or -3dB from 4kHz up); low shelf (0dB or -3dB from 250Hz down); desktop (+3.5dB between 1kHz and 10kHz and -1dB below 400Hz)

高性能低音倒相口

使用A2DP协议的蓝牙

56-bit DSP 内部分辨率

系统总延迟 (模拟输入)：1.02 ms

系统总延迟 (蓝牙输入)：155 ms (取决于播放主机，使用iPhone 6S/iOS 10.0.1测试)

接口：2x RCA 非平衡输入；3.5mm AUX 立体声输入 (非平衡)；4-pin 音箱接口

尺寸 (英寸)：180mm x 135mm x 90mm (7" x 5.31" x 3.54")

重量 (oz) 920g (32.45oz) 左音箱 - 800g (28.22oz) 右音箱

保修政策

请访问www.ikmultimedia.com/warranty 查看完整的保修政策

支持及更多信息

www.ikmultimedia.com/support

www.iloudmm.com

Regulatory

Model: iLoud Micro Monitor
Model Number: IK000072

U.S.A.

FCC ID : 2AAYP-072900001



FCC statement

This device complies with Part 15 of the FCC Rules. Operation is subject to the following two conditions:

1. This device may not cause harmful interference.
2. This device must accept any interference received, including interference that may cause undesired operation.

Changes or modifications not expressly approved by the party responsible for compliance could void the user's authority to operate the equipment.

NOTE: This equipment has been tested and found to comply with the limits for a Class B digital device, pursuant to Part 15 of the FCC Rules. These limits are designed to provide reasonable protection against harmful interference in a residential installation.

This equipment generates, uses, and can radiate radio frequency energy and, if not installed and used in accordance with the instructions, may cause harmful interference to radio communications. However, there is no guarantee that interference will not occur in a particular installation. If this equipment does cause harmful interference to radio or television reception, which can be determined by turning the equipment off and on, the user is encouraged to try to correct the interference by one or more of the following measures:

1. Reorient or relocate the receiving antenna.
2. Increase the separation between the equipment and receiver.
3. Connect the equipment into an outlet on a circuit different from that to which the receiver is connected.
4. Consult the dealer or an experienced radio/TV technician for help.

FCC radiation exposure statement

This equipment complies with FCC radiation exposure limits set forth for an uncontrolled environment. This equipment should be installed and operated with minimum distance 20cm between the radiator & your body. End users must follow the specific operating instructions for satisfying RF exposure compliance. This transmitter must not be co-located or operating in conjunction with any other antenna or transmitter.

CANADA

IC ID: 11298A-072900001

IC statement/warning

This device complies with Industry Canada licence-exempt RSS standard(s). Operation is subject to the following two conditions:

1. This device may not cause interference, and
2. This device must accept any interference, including interference that may cause undesired operation of the device.

To comply with Industry Canada RF radiation exposure limits for general population, the antenna(s) used for this transmitter must be installed such that a minimum separation distance of 20cm is maintained between the radiator (antenna) and all persons at all times and must not be co-located or operating in conjunction with any other antenna or transmitter

Changes or modifications not expressly approved by the party responsible for compliance could void the user's authority to operate the equipment.

Avertissement IC

Le présent appareil est conforme aux CNR d'Industrie Canada applicables aux appareils radio exempts de licence. L'exploitation est autorisée aux deux conditions suivantes:

1. l'appareil ne doit pas produire de brouillage, et
2. l'utilisateur de l'appareil doit accepter tout brouillage radioélectrique subi, même si le brouillage est susceptible d'en compromettre le fonctionnement.

Pour satisfaire les limites d'exposition aux radiations RF de l'Industrie Canada, les antennes utilisées pour cet émetteur doivent être installées de façon telle qu'au moins 20cm séparent l'émetteur (antenne) de toute personne, et ne doivent être ni situées ni utilisées en conjonction avec n'importe quelle autre antenne ou émetteur.

EUROPE



AUSTRALIA/NEW ZEALAND



JAPAN

This equipment contains specified radio equipment that has been certified to the Technical Regulation Conformity Certification under the Radio Law.

This equipment contains:



CHINA



CMIIT ID: 2017DJ0504

iLoud® Micro Monitor is a trademark or registered trademark property of IK Multimedia Production Srl. All other product names and images, trademarks and artists names are the property of their respective owners, which are in no way associated or affiliated with IK Multimedia.